

# Gebrauchsanleitung / Instructions / Mode d'emploi / Gebruiksaanwijzing / Instrucciones

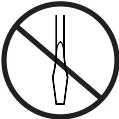

1:1  
DIN A3

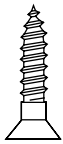

ca. 0,5h

<b>B</b>		8x 681 0775
<b>C</b>		8x 681 0773
<b>D</b>		8x 681 0774
<b>E</b>		2x 681 0253
<b>F</b>		4x 681 2047
<b>S</b>		7 x 15 16x 683 0022

## Version 2015

1

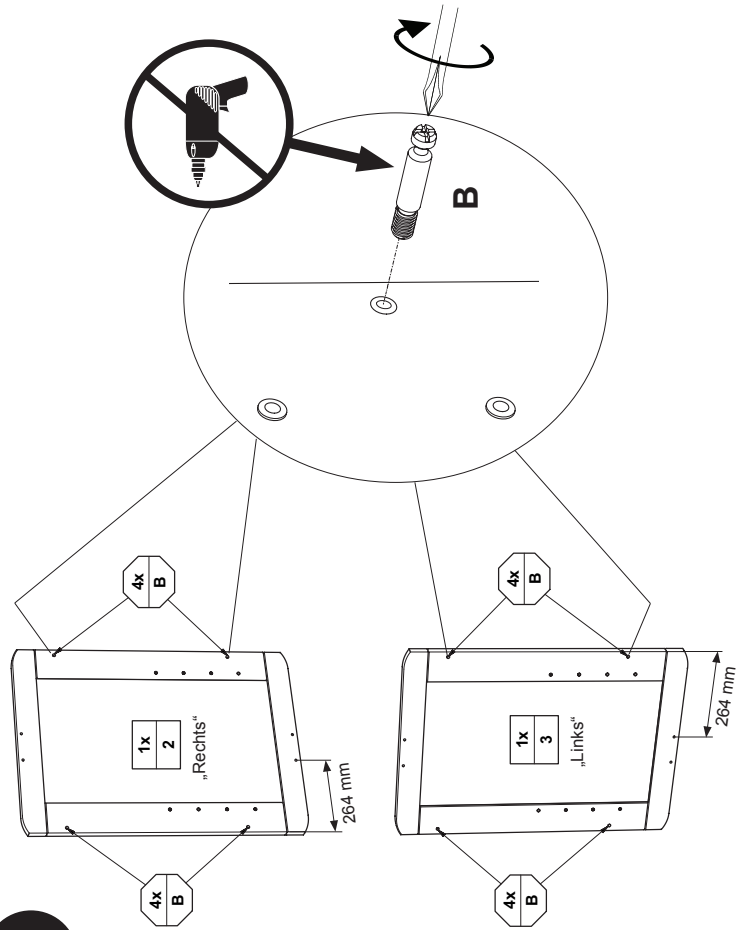

TRANSLAND GmbH  
Möbel und Textil  
Hauptstraße 87  
D-97840 Hafentlohr/Main



**Kinderbett  
60x120**

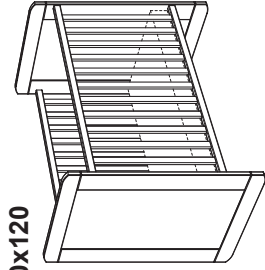

**MATTES  
176 9479**

**MATS  
176 9476**

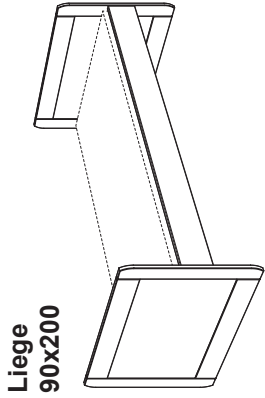

**Liege  
90x200**

**Kinderbett  
60x120**

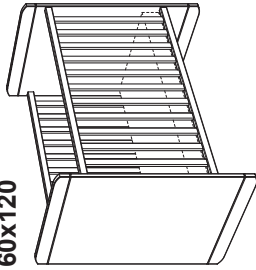

**ALISA  
176 4020**

**METAMORPHOSE  
176 4220**

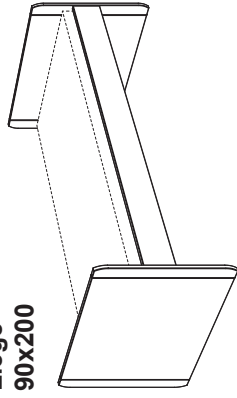

**Liege  
90x200**

**Kinderbett  
60x120**

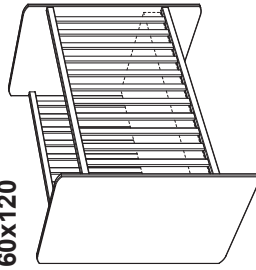

**HILJA  
176 9654**

**LORIE  
176 9611**

**GRETA  
176 9637**

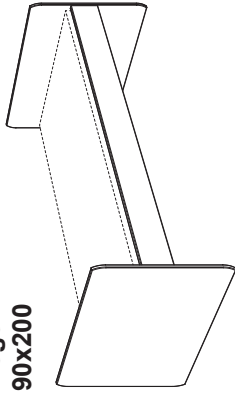

**Liege  
90x200**

DE FR GB NL ES GR IT CZ SK SI DK SE FI PL HU RO BG HR LT RU CN

**Pflegehinweis:** Zum Reinigen der Oberflächen ein leicht-feuchtes Tuch oder ein handelsübliches Möbelpflege Mittel verwenden.  
**Indication sur l'entretien:** pour nettoyer les surfaces, utiliser un chiffon légèrement humide ou un nettoyant pour meubles en vente dans le commerce.  
**Caring for the...:** in order to clean the surfaces please use a slightly damp cloth or commercially available furniture care product.  
**Verzorgingsaanwijzing:** Voor het reinigen van de oppervlakken een licht vochtig doek of een gebruikelijk meubelschoonmaakmiddel gebruiken.  
**Recomendaciones de cuidado:** Para limpiar las superficies del mueble debe usar un trapo húmedo o un producto de limpieza de muebles comercial.  
**Объяснение по уходу:** Для очистки поверхности мебели используйте влажную тряпку или обычное средство по уходу за мебелью.  
**Indicazione per pulizia e cura:** Per la pulizia delle superfici utilizzare un panno leggermente umido o un normale prodotto per la cura dei mobili.  
**Pokyny k čistení:** Na čištění povrchu použijte pouze navlhčený kousek látky nebo běžný prostředek na ošetrování nábytku.  
**Navodilo za nego:** Za čiščenje površin uporabljajte malo vlažno črtno ali trgovsko običajno sredstvo za nego pohištva.  
**Pjele:** Rens overflader med en fugtig klud eller med et gængs møbelplejemiddel.  
**Skötselråd:** Rengör yorna med en fuktig trasa eller med ett vanligt möbelföringsmedel som finns i handeln.  
**Holto-ohje:** Käytä pintojen puhdistukseen kosteata pyyhettä tai yleisen kauppaladun mukaista huonekalujen hoido-ainetta.  
**Wskazówka pielęgnacyjna:** do czyszczenia powierzchni stosować lekko wilgotną ściereczkę lub zwykły środek do pielęgnacji mebli.  
**Apórási útmutatás:** A felület tisztításához egy enyhén nedves kendőt, vagy kereskedelemben kapható, szokványos bútorgépelő szert használjon.  
**Indicatiile de întreținere:** pentru curățarea suprafețelor folosiți o cârpă umezită ușor sau un produs comercial obișnuit pentru îngrijirea mobilierului.  
**Указание за поддръжка:** Използвайте леко навлажнена кърпа или обикновен препарат за поддръжка на мебели, за да почистите повърхностите.  
**Upute za njegu:** Za čišćenje površina upotrijebite jednu iko navlaženu krpú i trgovsko uobičajeno sredstvo za njegu namještaja.  
**Rekomendacija prijezštavanja:** Površius valjklie drégná pasliušite arba pardotuotvėse įsigijomus būdų priežiūros priemonėms.  
**Рекомендация по уходу:** для очистки поверхностей используйте слегка влажную тряпку или обычное средство по уходу за мебелью.  
**保養說明:** 清潔表面宜用稍濕的布或普通的家具清潔劑即可。

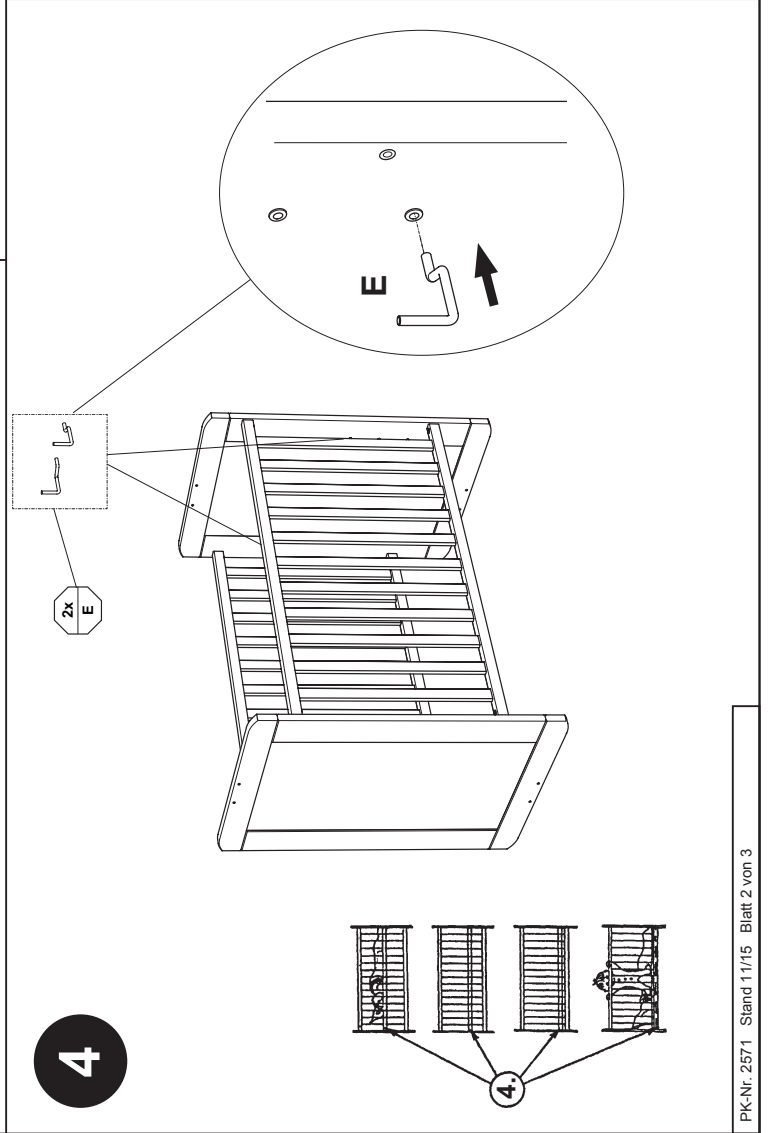
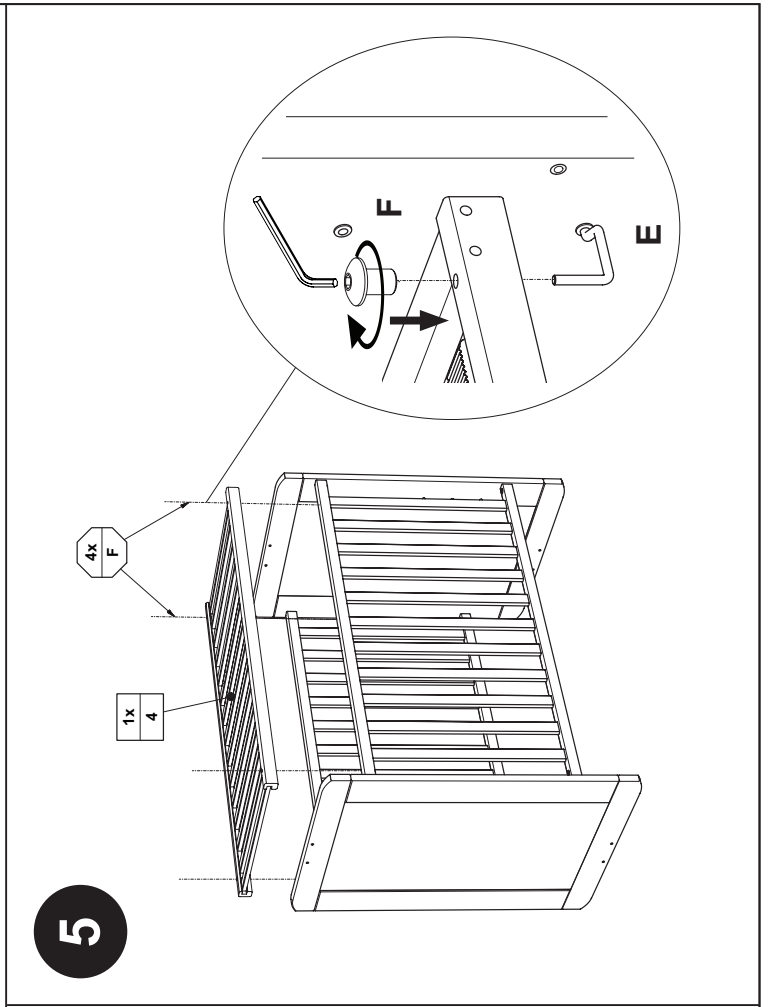
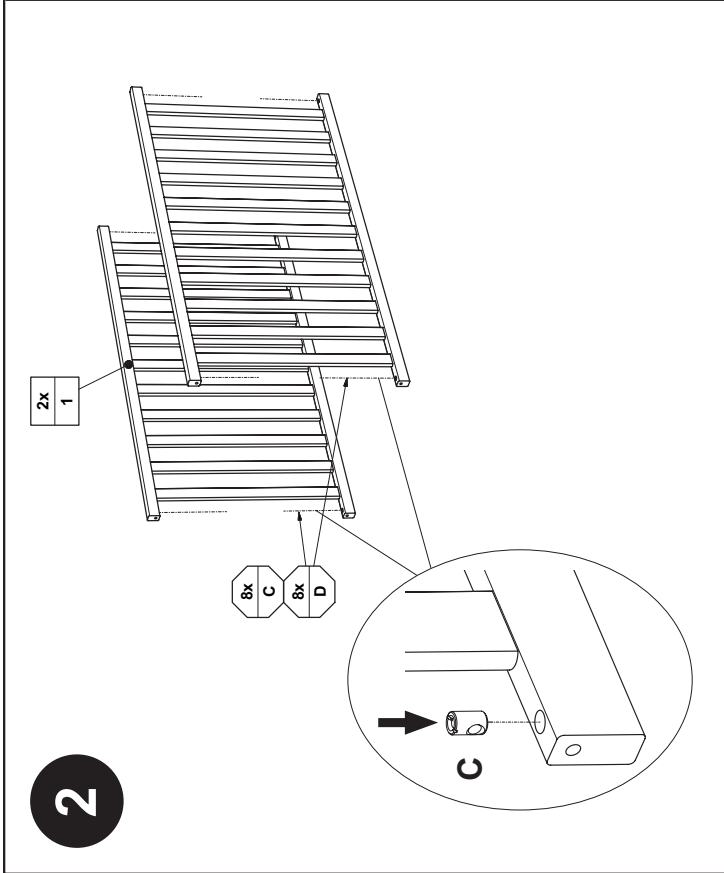
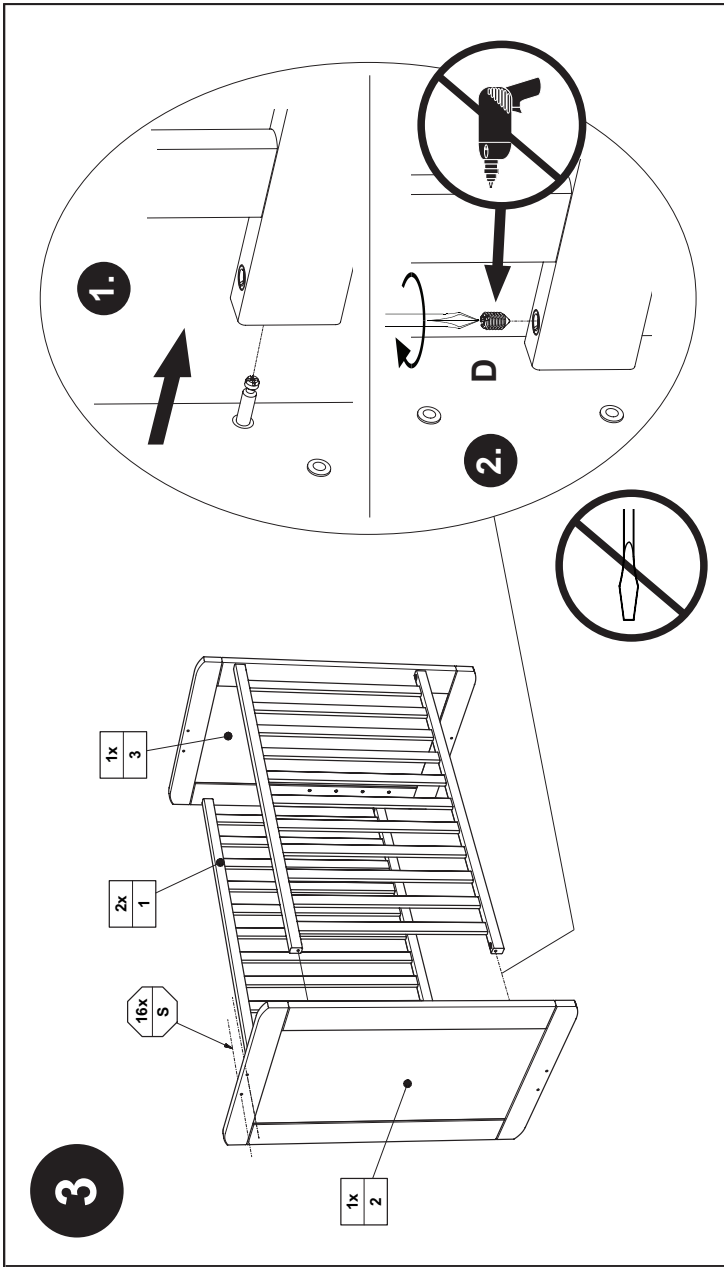

# Gebrauchsanleitung / Instructions / Mode d'emploi / Gebruiksaanwijzing / Instrucciones

TRANSLAND GmbH  
Möbel und Textil  
Hauptstraße 87  
D-97840 Haftenlohr/Main



1:1  
DIN A3

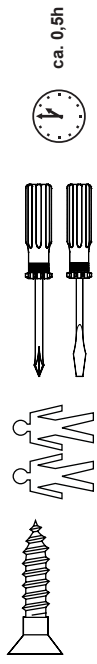

<b>M</b>		6,3 x 18 16x	8x 8x	681 5095 681 3972
<b>N</b>		M6 x 65	8x	681 1665
<b>O</b>		SW4	1x	681 3011

**1**

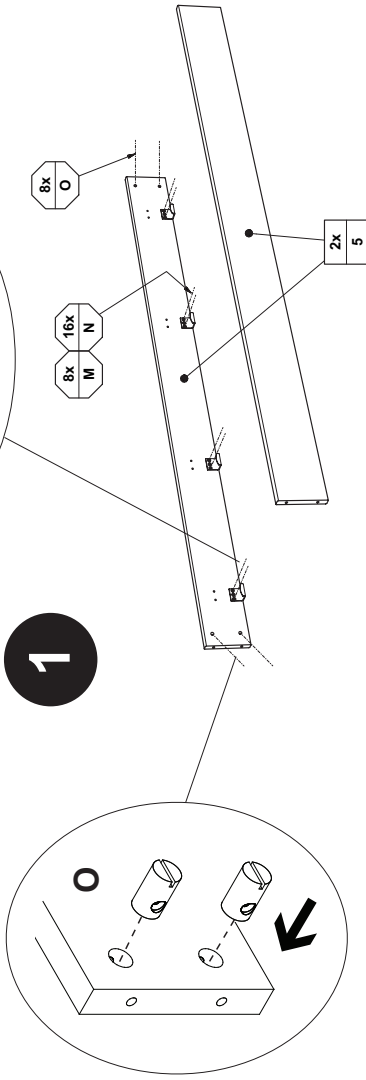

**Betrifft eine niedrige Matratze**  
thin mattress  
matelas basse  
voor een lage matras  
Para un colchón bajo

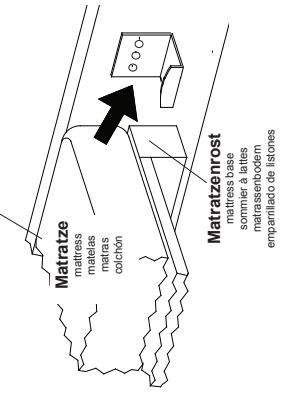

**Betrifft eine hohe Matratze**  
thick mattress  
matelas haute  
voor een hoge matras  
Para un colchón alto

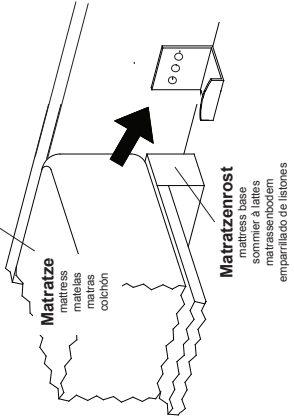

**2**

