

Gebrauchsanleitung / Instructions / Mode d'emploi / Gebruiksaanwijzing / Instrucciones

TRANSLAND GmbH
Möbel und Textil
Hauptstraße 87
D-97840 Hafentlohr/Main

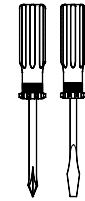

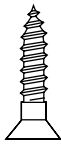





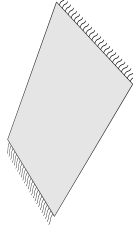









1:1
DIN A3









ca. 1,5h



A		ø8 x 35 20x 681 0702	4x 681 0859
B		3,5 x 15 22x 681 2639	4x 681 1647
C			
D			
E		6x 681 2640	6x 681 2640
F		3x 681 2642	3x 681 2642
G		4x 681 0351	4x 681 0351
H		4x 681 0757	4x 681 0757
I		4,0 x 30 10x 681 4910	4x 681 4910
J		16x 681 7164	16x 681 7164
K		4x 681 8052 SILBER	4x 681 8052 SILBER

K		4x 681 8052 SILBER
L		4x 681 4896
M		1x 681 0868
N		1x 681 0864
O		6x 681 2630
P		3x 681 2631

R		12x 681 0350	12x 681 4914
S		3,0 x 20 16x 681 4914	14x 681 2498
T			
U		3x 681 8051 SILBER	3x 681 8051 SILBER
U		3x 681 8437 NICKEL	3x 681 8437 NICKEL
U		3x 681 8442 SILBER	3x 681 8442 SILBER
I		4,0 x 30 19x 681 4910	4,0 x 30 19x 681 4910

Wandbefestigung

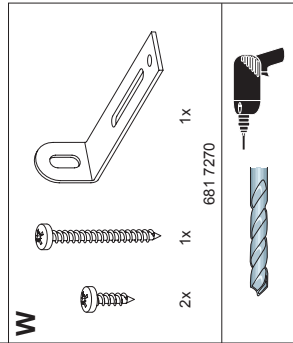







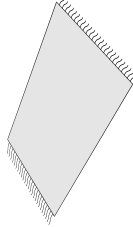





W
2x
681 7270
1x
681 2498



ca. 1,5h



K		4x 681 8052 SILBER
L		4x 681 4896
M		1x 681 0868
N		1x 681 0864
O		6x 681 2630
P		3x 681 2631

R		12x 681 0350	12x 681 4914
S		3,0 x 20 16x 681 4914	14x 681 2498
T			
U		3x 681 8051 SILBER	3x 681 8051 SILBER
U		3x 681 8437 NICKEL	3x 681 8437 NICKEL
U		3x 681 8442 SILBER	3x 681 8442 SILBER
I		4,0 x 30 19x 681 4910	4,0 x 30 19x 681 4910

Wandbefestigung

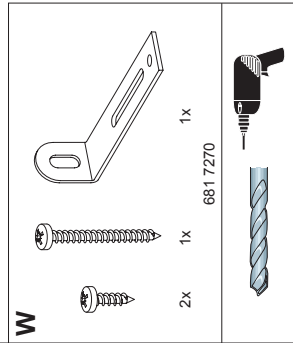

W
2x
681 7270
1x
681 2498

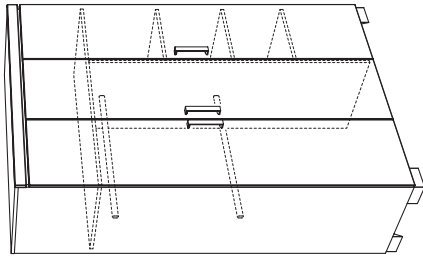

HILJA
176 0154
ALISA
176 4023
KRISTIN
176 0156

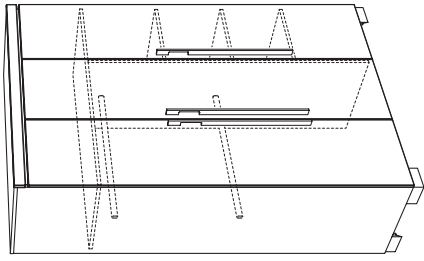

LORIE
176 0111



DE Achtung ! Beiliegende Wandbefestigungen müssen montiert werden !
FR Attention ! Les fixations murales ci-jointes doivent être montées !
GB Attention ! The enclosed wall mountings must be fitted !
NL Let op ! De meegeleverde wandbevestigingen moeten worden gemonteerd !
ES ¡Atención! Las fijaciones murales incluidas deben montarse !
GR Προσοχή ! Τα εξεργισμένα στοιχεία που περιλαμβάνονται στη συσκευασία πρέπει να συναρμολογηθούν !
IT Attenzione ! Occorre montare i fissaggi per attacco alla parete qui allegati !
CZ Pozor ! Přiložené úchytky musí být namontovány na stěnu !
SK Pozor ! Priložené úchytky musí byť namontované na stenu !
SI Pozor ! Namontirati je potrebno priložene elemente za pritrditev na zid !
DK OBS ! Vedlagte vægffastgørelsesmidler SKAL monteres !
SE Huomio ! Toimituksen mukana olevat seinäkiinnikkeet on asennettava !
PL Uwaga ! Załączone zamocowania do ściany muszą być zamontowane !
FI Figuelem ! A melkelt fall röggittöket össee kell szejnini !
HU A figyelje ! Trebules montate piesele de fixare in perete care sunt atasate !
RO Внимание ! Приложните закрепвания за стена трябва да бъдат монтирани !
BG Pozor ! Priložena zidna pričvršćenja moraju biti montirana !
HR Вниманіе ! Prilozena zidna pričvršćenja moraju biti montirana !
LT Dėmesio ! Pridedamos tvirtinimo prie sienos detales reikia sumontuoti !
RU Внимание ! Обязательно использовать прилагаемые крепления стене !
CN 注意 ! 附带的墙壁安装组件必须安装 !
AR تنبه ! لا بد من تركيب الجدران على الحائط !

DE Pflegehinweis : Zum Reinigen der Oberflächen ein leicht-feuchtes Tuch oder ein handelsübliches Möbelpflegemittel verwenden.
FR Indication sur l'entretien : pour nettoyer les surfaces, utiliser un chiffon légèrement humide ou un nettoyeur pour meubles en vente dans le commerce.
GB Caring for the... : In order to clean the surfaces please use a slightly damp cloth or commercially available furniture care product.
NL Verzorgingsaanwijzing: Voor het reinigen van de oppervlakken een licht vochtig doek, of een gebruikelijk meubelschoonmaakmiddel gebruiken.
ES Recomendaciones de cuidado: Para limpiar las superficies del mueble debe usar un trapo humedecido o un producto de limpieza de muebles comercial.
GR Οδηγίες τριτοποίησης: Για το καθαρισμό των επιφανειών να χρησιμοποιείτε ένα ελαφρά υγρό ή καθαρό εμπορικό προϊόν καθαρισμού.
IT Indicazioni per pulizia e cura: Per la pulizia delle superfici utilizzare un panno leggermente umido o un normale prodotto per la cura dei mobili.
CZ Pokyn k ošetrovani: Na čištění povrchu použijte pouze navlhčený kousek látky nebo běžný prostředek na ošetrování nábytku.
SK Pokyn k ošetrovani: Na čištění povrchu použijte miernu navlhčenú handru alebo bežný čistiaci prostriedok na ošetrovanie nábytku.
DK Navodilo za nego: Za čišćenje površine uporabljajte malo vlažno črno ali trgovsko običajno sredstvo za nego pohištva.
SE Skötselråd: Rengör ytorerna med en fuktig trasa eller med ett vanligt möbelföringsmedel som finns i handeln.
PL Hoto-obje: Kąpa phtobn puhdsztoszenie kosteala ruhyhetá tá yleisen kauppalaidun mukaista huonekalujen hoito-ainetta.
FI Wskazówka pielęgnacyjna: do czyszczenia powierzchni stosować lekko wilgotną ściereczkę lub zwykły środek do pielęgnacji mebli.
HU Alopási útmutatás: A felületek tisztításához egy enyhén nedves kendőt, vagy kereskedelemben kapható, szokványos bútorápoló szert használjon.
RO Indicatii de intretinere: pentru curățarea suprafețelor folosiți o cârpă umezită ușor sau un produs comercial obișnuit pentru îngrijirea mobilierului.
BG Указания за поддържане: Използвайте леко навлажнена кърпа или обичоен препарат за поддържане на мебели, за да почистите повърхностите.
HR Upute za njegu: Za čišćenje površina upotrijebite jednu iako navlaženu krpú i trgovacko običajno sredstvo za njegu namještaja.
LT Rekomendacija priežiūrai: Pavišius valkytė drėgna pašluoste arba patalutovėse įsigytomis baldų priežiūros priemonėmis.
RU Рекомендации по уходу: для очистки поверхностей используйте слегка влажную тряпку или обычное средство по уходу за мебелью.
CN 保養說明: 清潔表面只需用稍濕的布或普通的家具清潔劑即可。

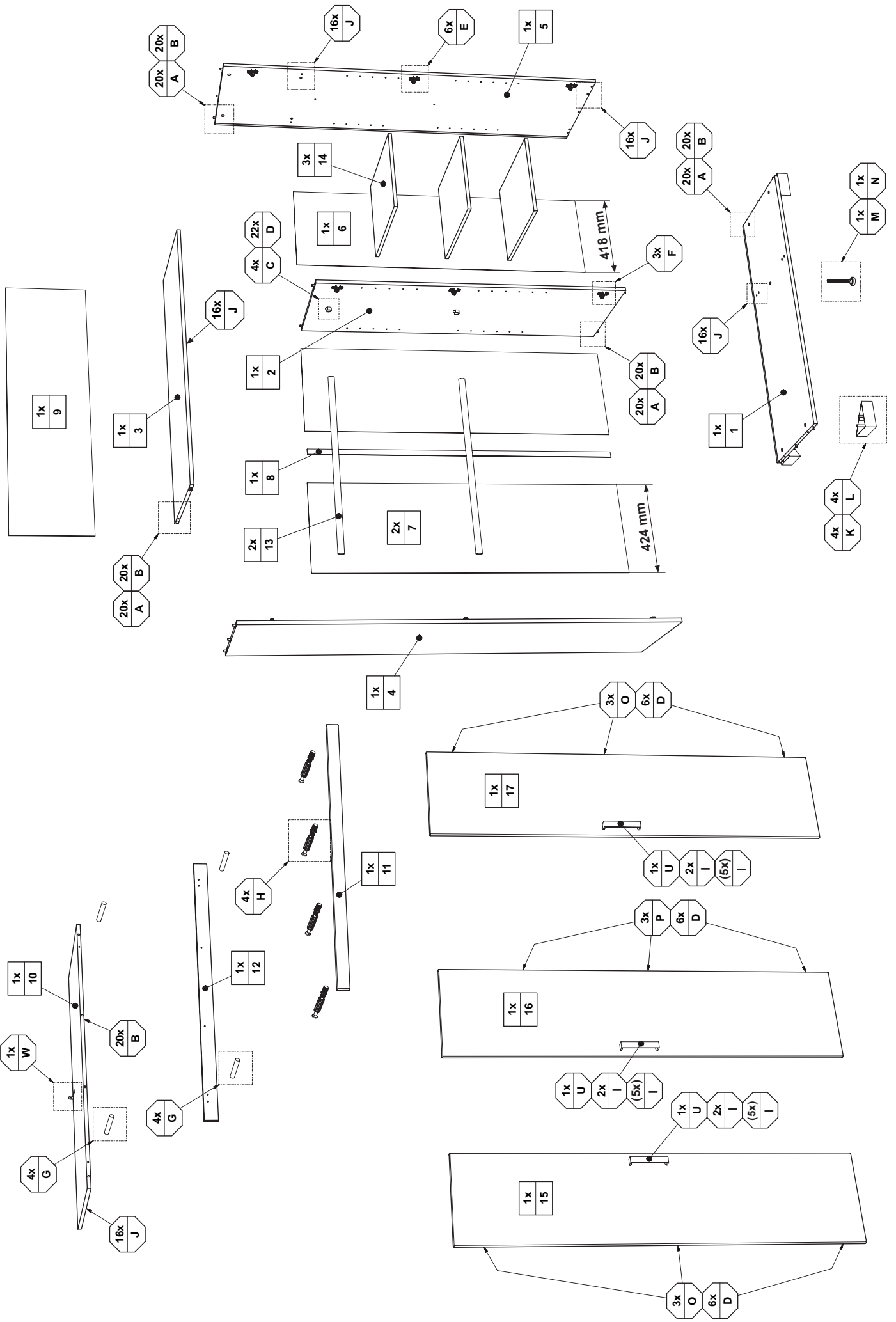

3

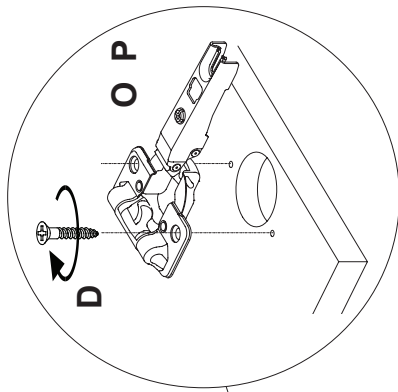
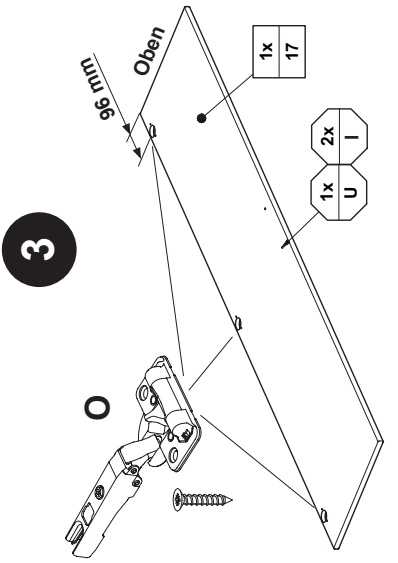

1

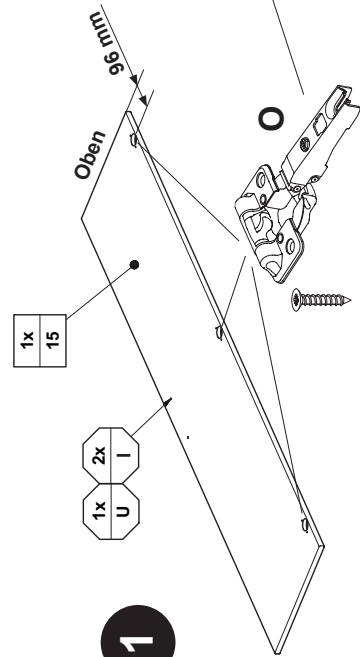

2

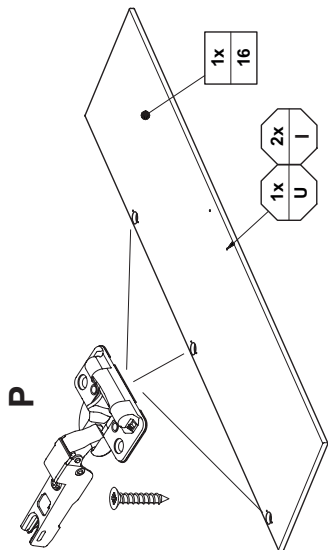

5

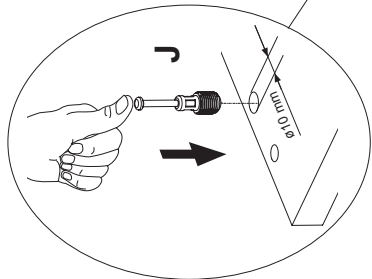

4

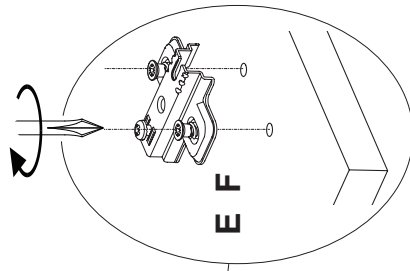
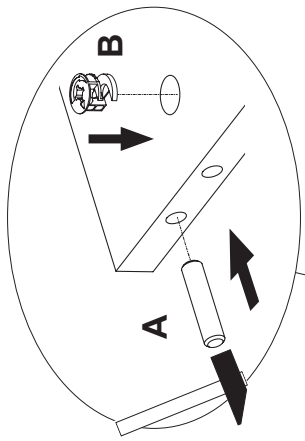
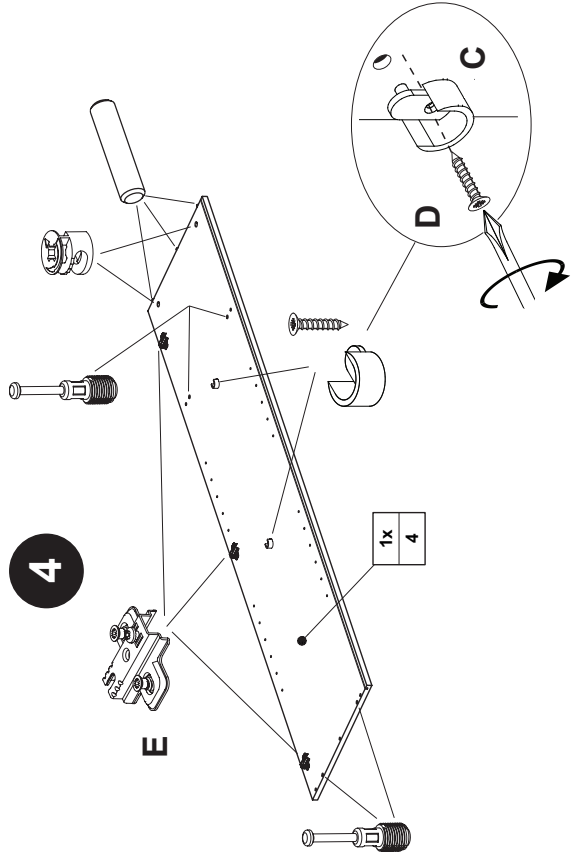

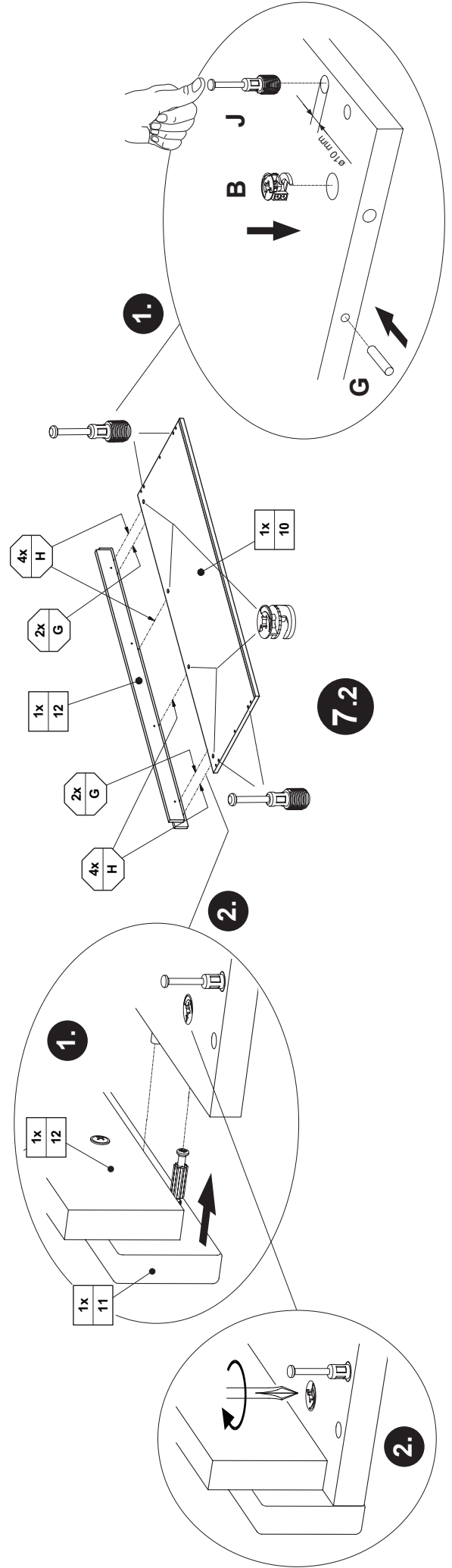
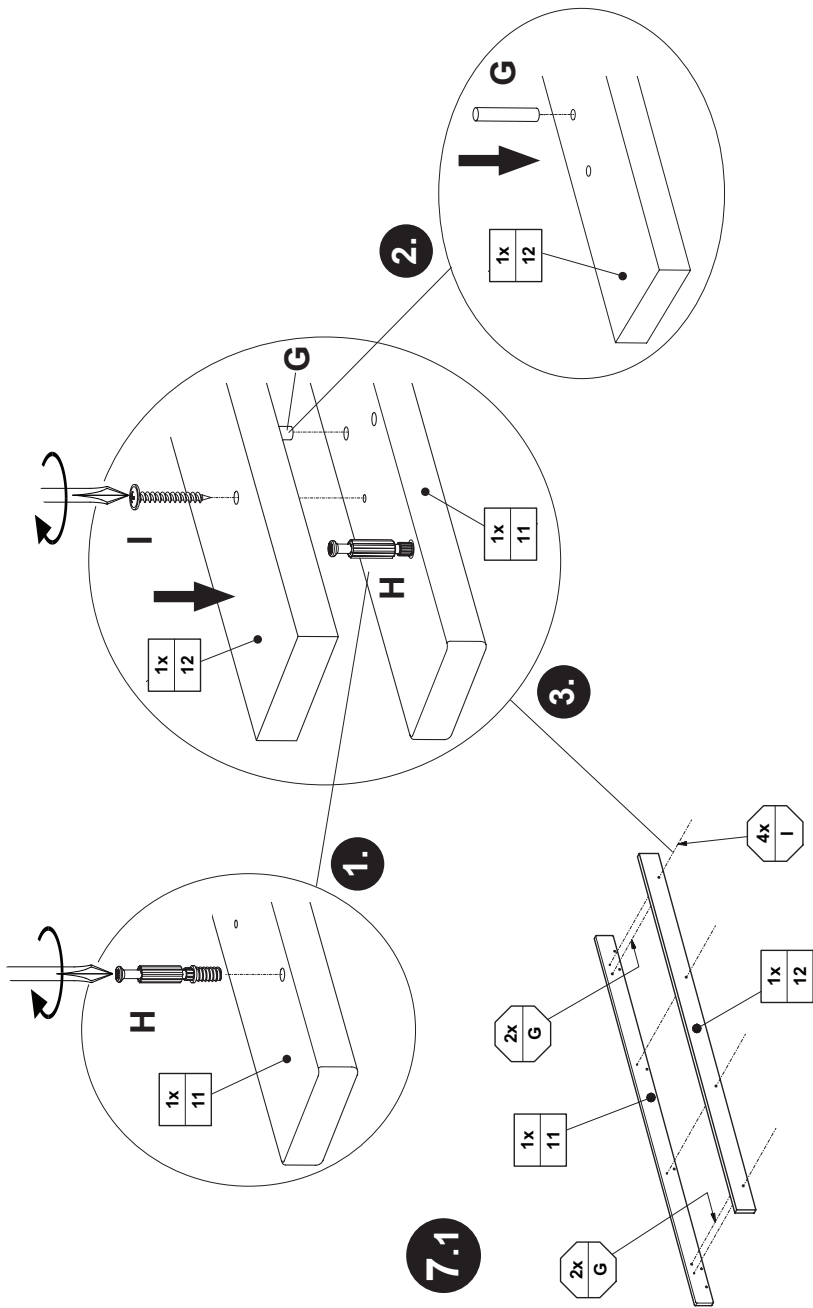
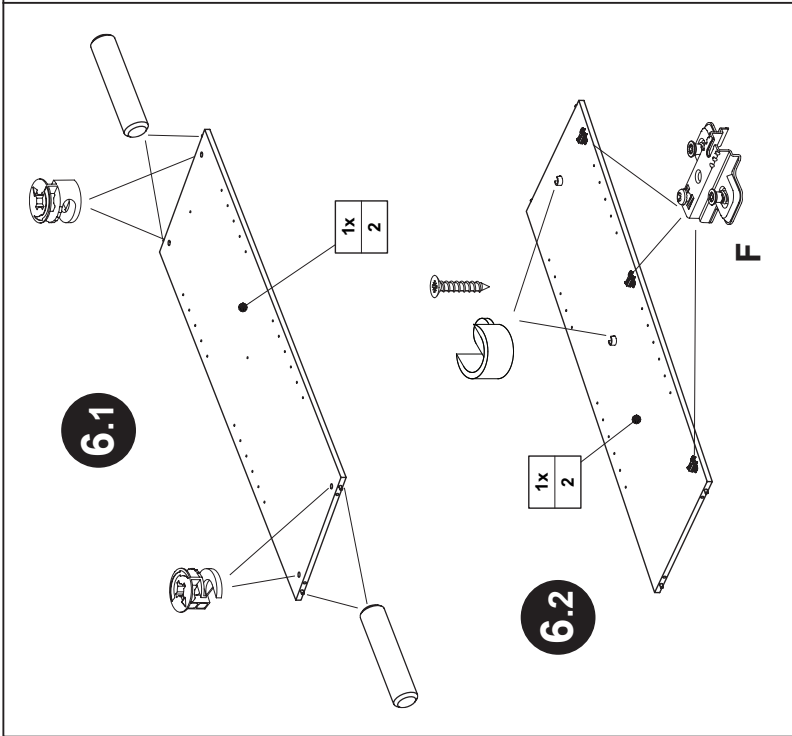

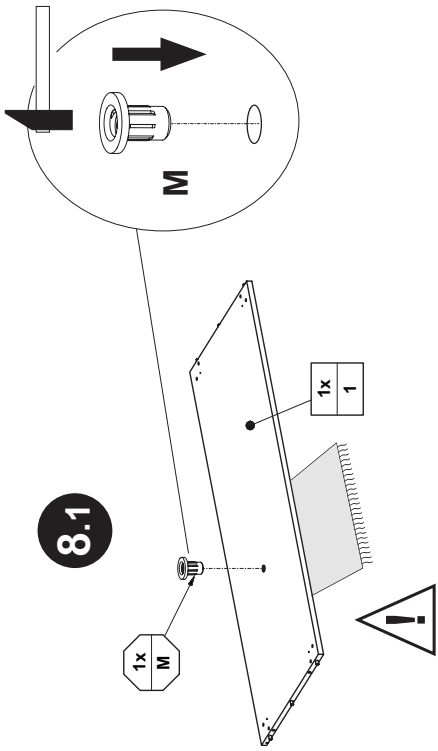

8.2

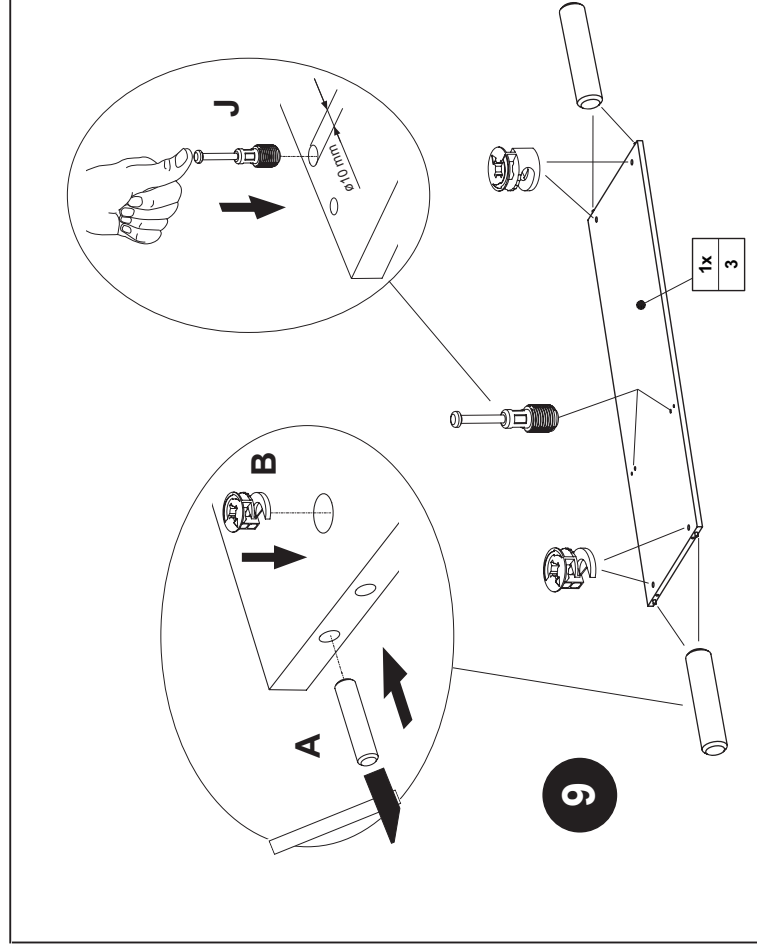
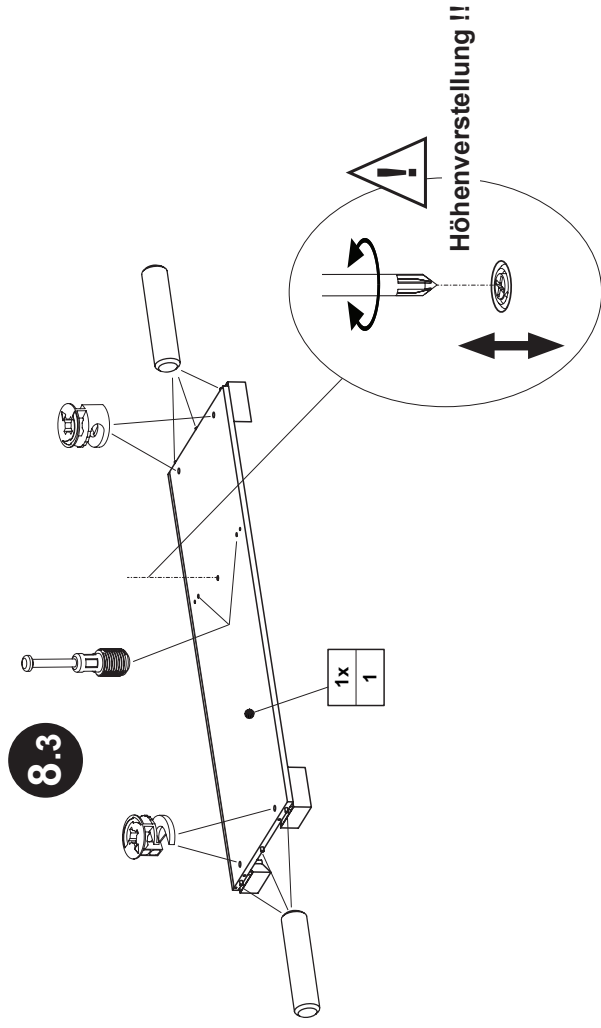
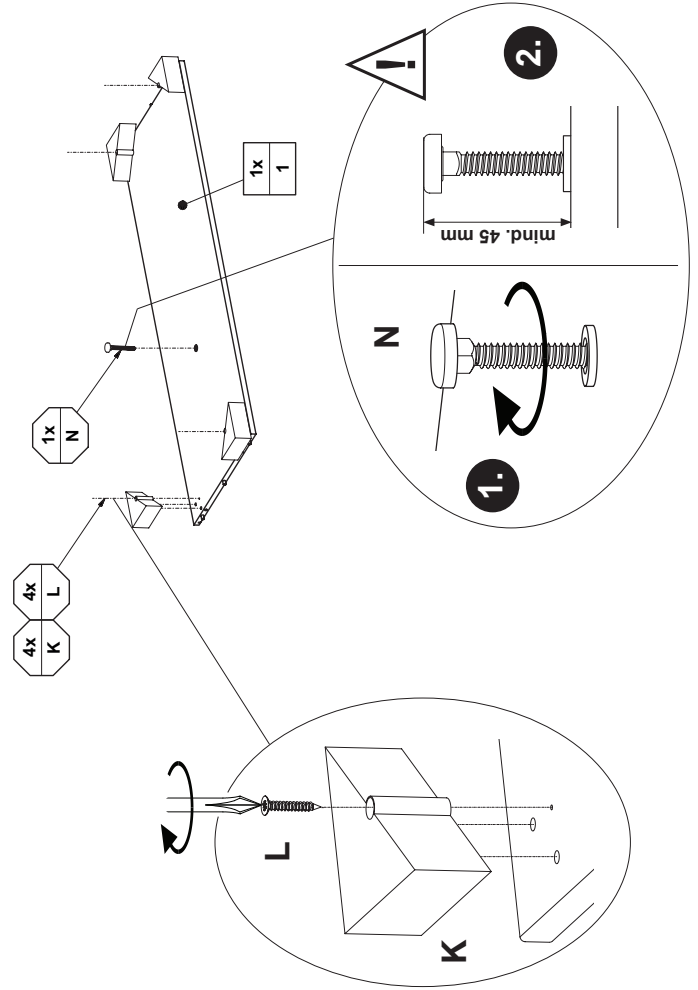

10

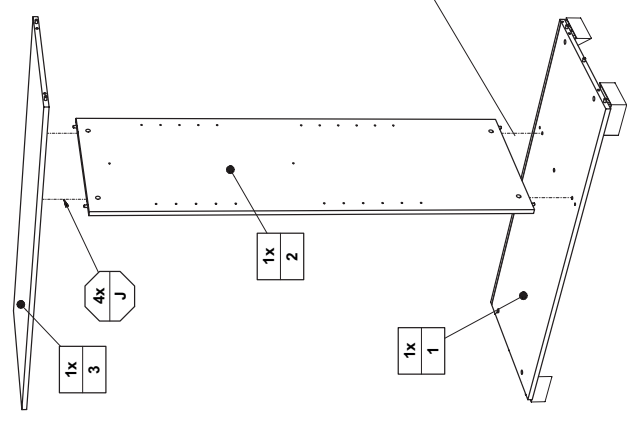

11

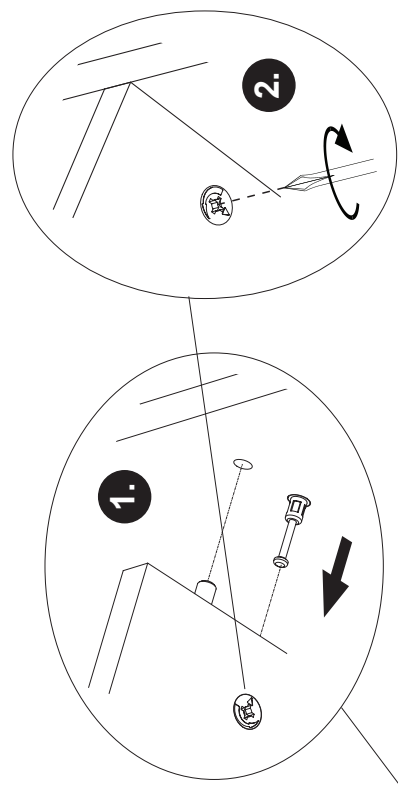
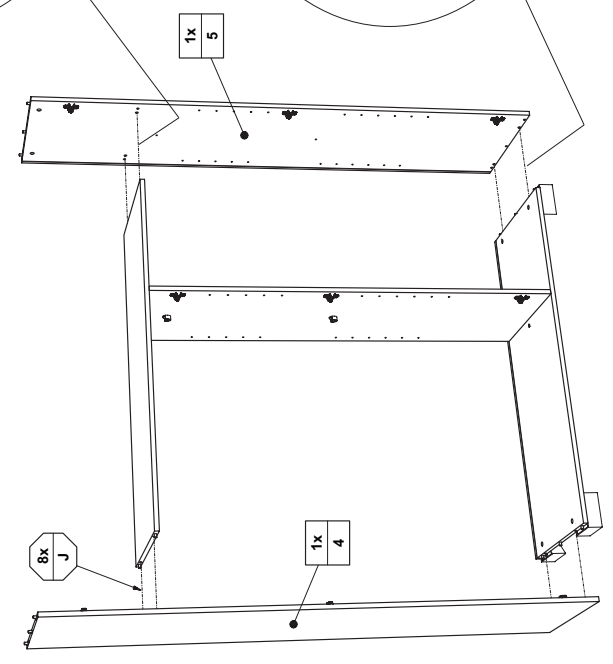

12

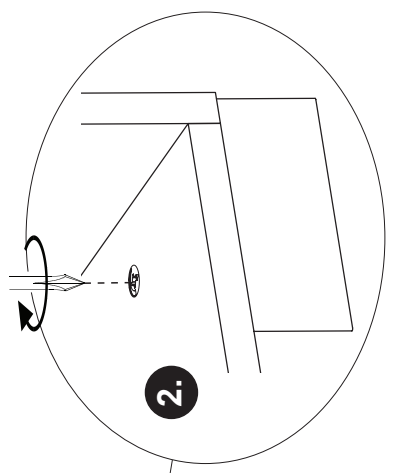
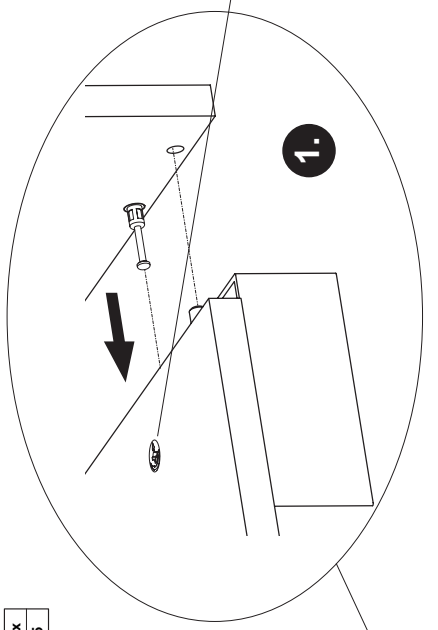
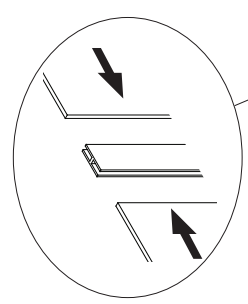
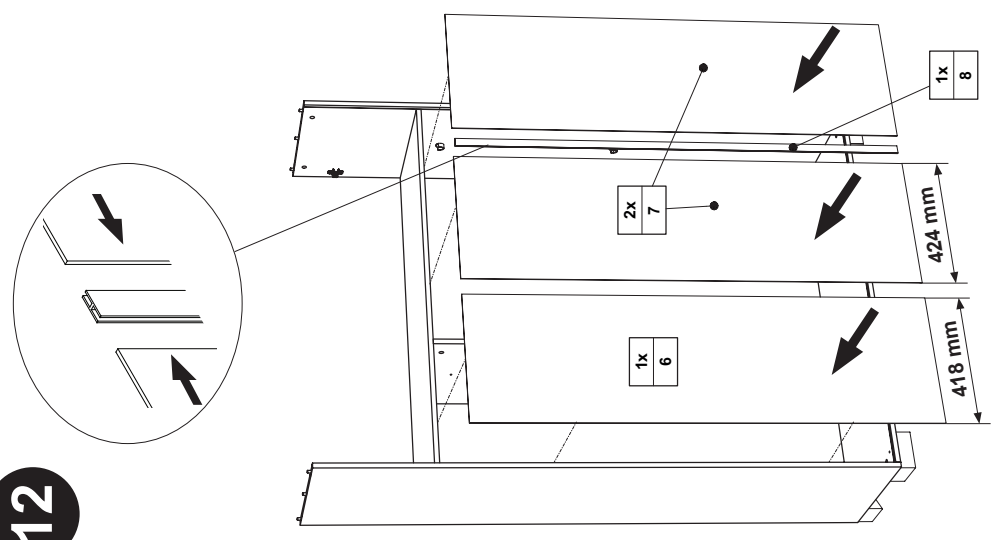

13

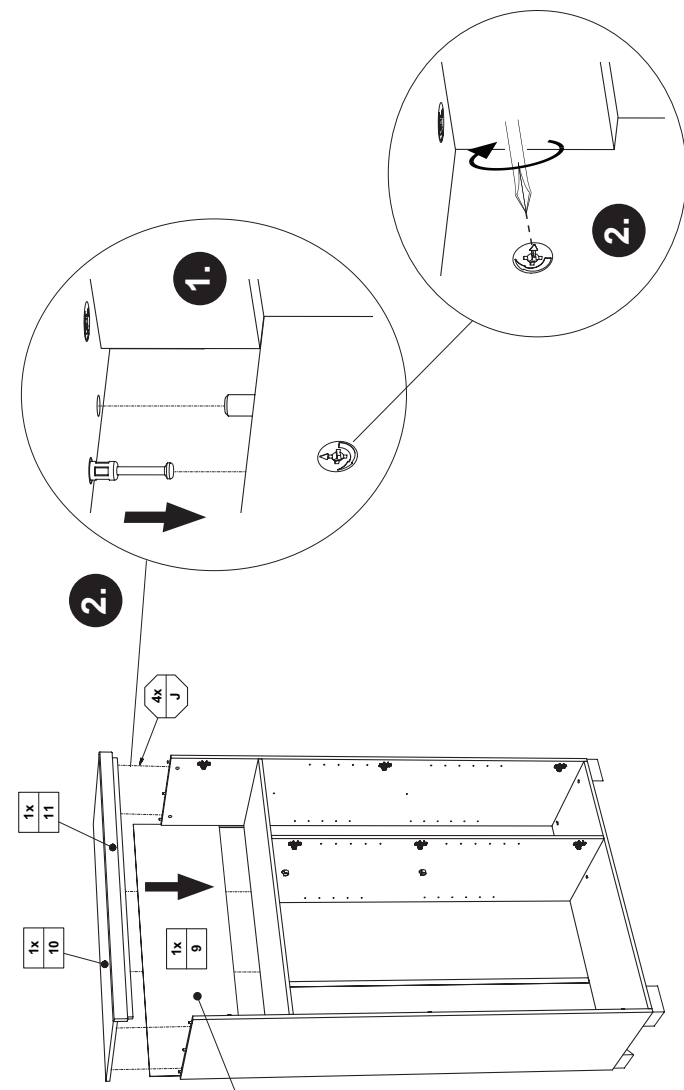

15

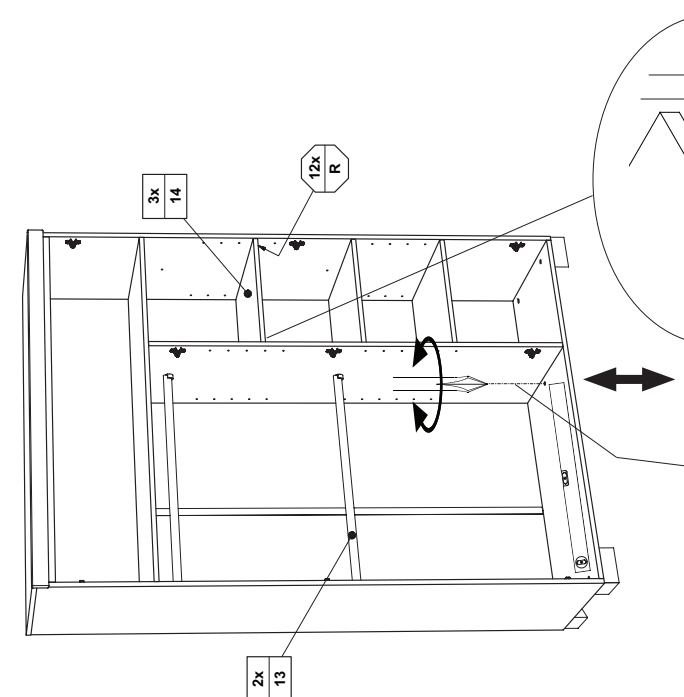

14

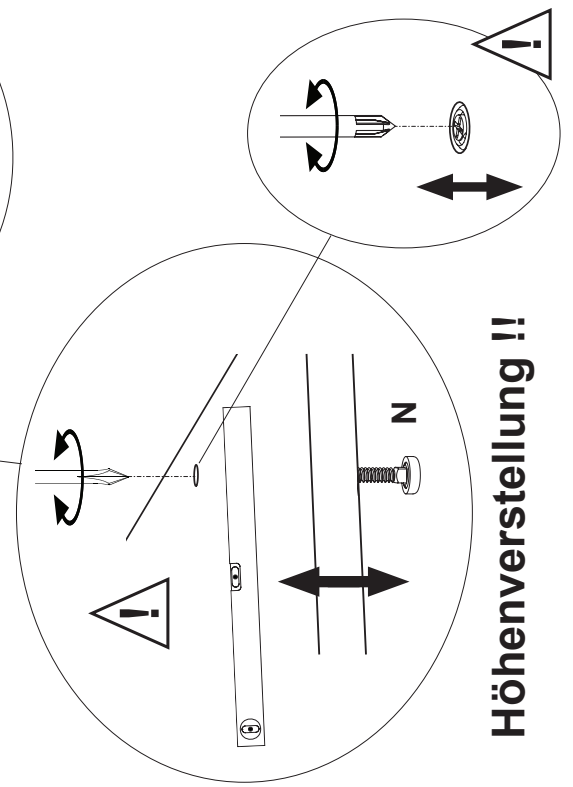
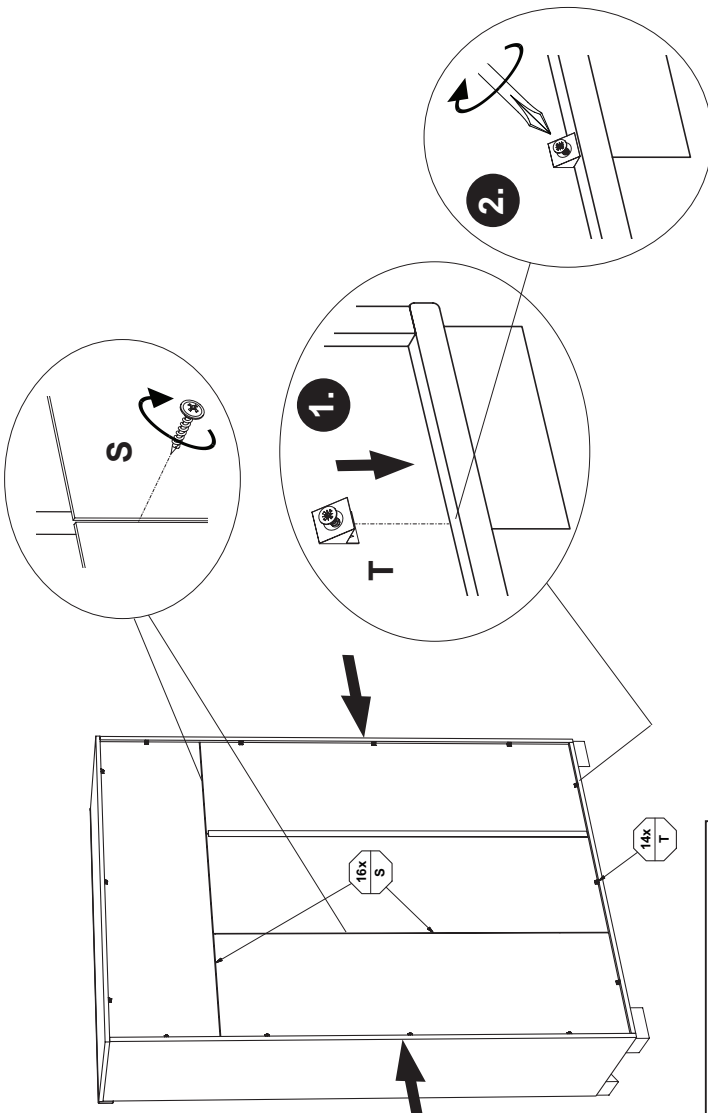

Höhenverstellung !!

16

1x 15

1x 16

1x 17

3x U
6x I
(15x) I

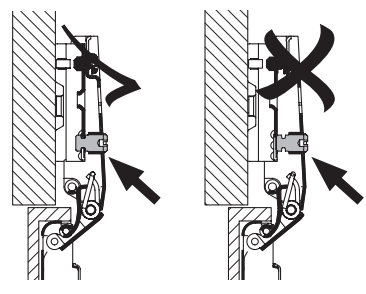
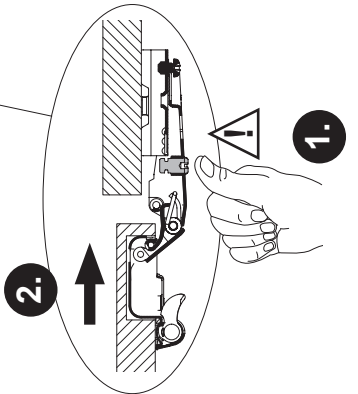
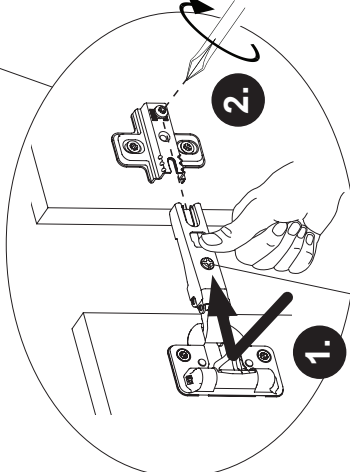
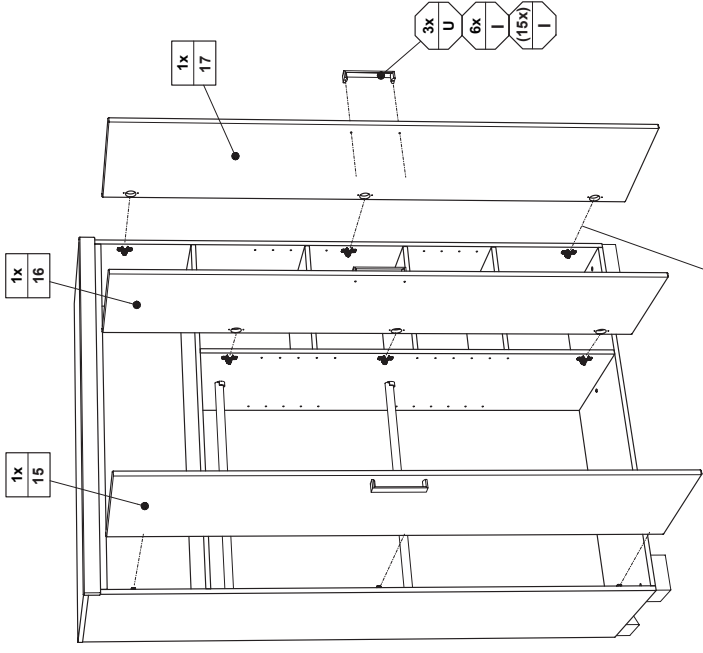

17

Kippsicherung !!



Da es viele verschiedene Wandmaterialien gibt, sind Wanddübel zur Wandbefestigung nicht beigebackt. Erkundigen Sie sich beim Fachhandel nach geeignetem Befestigungsmaterial.

